

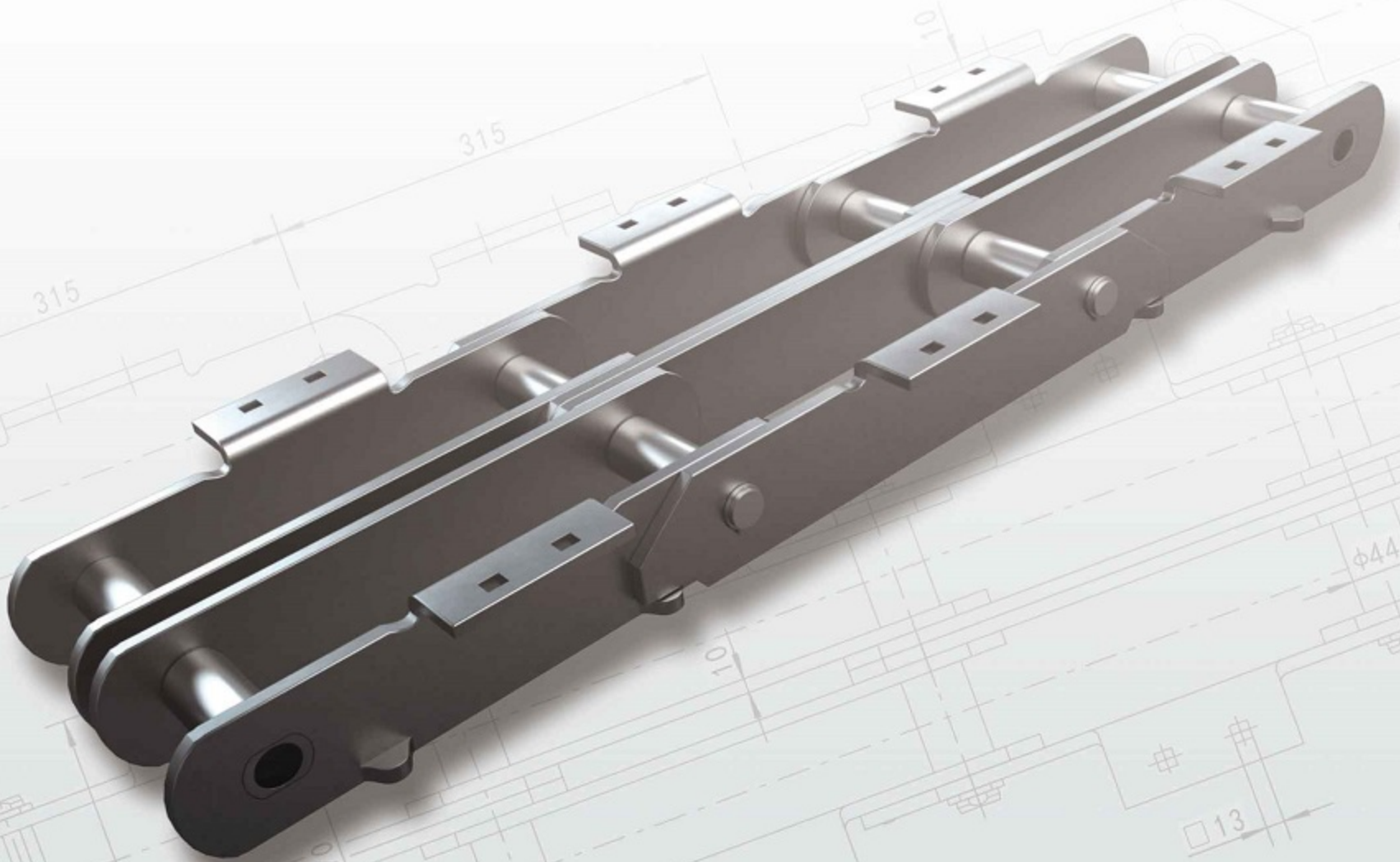

黄山牌

黄山链条
HUANGSHAN CHAIN

Since 1975
Transmit Safety & Reliability



<http://www.hschain.com.cn>





质量方针 Quality Policy

质量铸就品牌

顾客永葆满意

体系持续改进

致力于异型链条的制造先锋

Quality Cast Brand

Customers are always satisfied

System Keep Improving



Donating to be Manufacture Pioneer
for Nonstandard Chain



企业简介

BRIEF INTRODUCTION

安徽黄山恒久链传动有限公司，始建于1975年。隶属浙江恒久机械集团（CHJC），是中国大陆最具规模的链条制造厂商，致力于发展中大规格输送链和专用特种链的专业化生产。

公司生产的  链条，达6000多个品种规格。产品符合ISO、ANSI、DIN、BS和JIS标准，广泛应用于筑路、农牧、建筑、矿山冶金、水泥、木材加工、农牧、叉车、制浆造纸、粮油加工、啤酒饮料、冷食、日用化工、薄膜拉伸、棕榈油、制糖、再生资源回收处理、水处理、沼泽地作业设备等行业及家电、汽车生产线。 链条以其卓越的高可靠性表现，在诸多工业领域内享有盛誉。

公司建有省级企业技术中心、省级博士后科研工作站、省级工程技术研究中心三个创新平台，在研发设计、品质控制、生产制造、销售服务等方面，拥有一批经过专业培训、经验丰富的人员，专注于处理生产和服务过程中出现的问题，为客户选择和提供动力传动或物料输送系统的优化解决方案。



 链条以其卓越品质不仅在市场上获得客户的认可，同时也得到了来自政府的许多奖项，1998年起，

 链条连续获得“安徽名牌产品”“安徽省质量奖”“中国机械工业名牌产品”等殊荣。2011年黄山牌被认定为“中国驰名商标”。

公司自创建以来，一直坚持链传动制造及应用领域的技术研究和成果转化，开发新型的链条产品。运用先进的制造技术和高效的工艺装备，提升产品品质和扩大生产能力。实施ERP系统改善业务流程，整合企业资源，提高企业核心竞争力和领先优势。

公司将致力于设计和制造更高品质的链传动产品，并通过国际销售网络，更好地服务全球范围内的工业领域客户。

Anhui Huangshan Chain Transmission Co., Ltd. was founded in 1975, is a branch company for Zhejiang Hengjiu Machinery Group (CHJC) and the chain manufacturer with the largest scale in Chinese mainland, the company is committed to the development of the specialized production for large size transmission chain and special chain.

 Chain which the company manufactured covers more than 6000 different varieties and specification. They can meet ISO, ANSI, DIN, BS and JIS standard and are widely used for such industries as road construction, building construction, lumber process, agricultural machinery, fork lift, pulp & paper, grain & oil process, beer & beverage, cold food, household chemicals, film forming, palm oil, sugar mill, recovery of renewable resource, sewage treatment, marsh buggy equipment and appliance automobile lines etc. With its super-excellent reliable performance,  chain enjoyed great reputation among most of industrial areas.

Company owned three provincial level innovation platforms: Enterprise Technology Center, Post-doctoral Research Center and Engineer Research Center. Company also has group of well-trained and experienced employees in development & design, quality control, manufacture and sales service department. Who are concentrate on handling the problems appears during manufacture and service process, to select and provide the optimized solution for customer in power transmission or material handling system.

With its excellent quality,  chain not only obtains the approval from customer, but also wins many prizes from the government. From year 1998,  chain won the "Anhui Province Brand Product", "Anhui Province Quality Award", "Machinery Industry Brand Product of China" and other rewards, in 2011, Huangshan brand has been identified as "Famous Trademark of China".

Since the inception of company, we persist in the technology research and industrialization for chain transmission manufacture and its application field, keep develop new chain products. Use the updated manufacture technique and efficient process equipment to improve the product quality and production capacity. With the implementation of ERP system, the company now improved the business process, achieved integration of plant resource, and increased the core competitiveness and leading advantages of the company.

TCompany will be committed to develop and manufacture new chain products with sterling higher quality, and will better serve the industrial clients on worldwide basis through international sales network.



历史沿革

History

- 1975 成立“安徽省黄山链条厂”
Establish of “Anhui Huangshan Chain Factory”



- 2004 企业改制，更名为“安徽黄山恒久链传动有限公司”，隶属于浙江恒久机械集团有限公司
Enterprise reformation, renamed as “Anhui Huangshan Hengjiu Chain Transmission Co., Ltd.”, part of Zhejiang Hengjiu Machinery Group

- 2006 通过省级企业技术中心认定
Won the province level technical center certificate



- 2009 “中国非标异型链研发生产基地”暨新厂项目奠基
Set foundation of new site project and “Chinese special chain research & development production base”



- 2010 被安徽省科学技术厅等认定为“高新技术企业”
Be awarded the title of “High-tech Enterprise” by Anhui province sci-tech hall



- 2012 工厂整体迁至绩溪县生态工业园区
Whole site move to Ecology industry zone in Jixi.



- 2014 建设“安徽省耐复杂环境链条工程技术研究中心”
Construct “Anhui Province Engineering Research Center of Chains which suit for complex environment”

- 2015 设立“博士后工作站”
“Postdoctoral Center”



生产及测试设备

Production and testing equipment

数控加工中心

CNC Machining Center



线切割机

Wire-cut Machine



大吨位压力机群

Large Tonnage Press Machines



自动冲压生产线

Automatic Press Line



焊接机器人

Welding Robot



自动焊接机群

Automatic Welding Machines



生产及测试设备

Production and testing equipment

连续式网带炉
Supporting-Idler Type Mesh-Belt Furnace



真空炉
Vacuum Furnace



无心磨床
Centerless Grinder



预拉机
Pre-stretch Machine



多用途箱式炉
Multipurpose Box-type Furnace



抛丸机
Shot Blasting Machine



自动装配机
Automatic Assembly Machine



平顶链加工生产线
Special production line for Flat-Top Chain



生产及测试设备

Production and testing equipment

直读光谱仪

Direct-reading Spectrometer



显微维氏硬度计

Micro Vickers Hardness Tester



布氏硬度计

Brinell Hardness Tester



链条测长仪

Chain Length Tester



3000kN 卧式拉力试验机

3000kN Horizontal Tensile Testing Machine



300kN 疲劳试验机

300kN Fatigue Testing Machine



冲击试验机

Impact Elasticity Tester



影像测量仪

Image Measuring Instrument



盐雾试验机

Salt Spray Tester



如何选择链条供应商

How to select your chain suppliers

客户在进行链条修理或替换时,不仅意味着增加采购和人工费用,同时存在由于设备停机所造成的产能损失和其它意外风险。因此链条的可靠性是顾客选择供应商最重要的因素,它能够提高设备利用率和减少维修费用。

❖ 链条的可靠性主要取决于链条的耐磨性能和疲劳强度指标。❖ 链条是依据于示意图内所描述的因素和链条的实际服役工况设计和制造,并由ISO9001质量管理体系授权的品质保证,达到客户所需的高可靠性的预期目标。

❖ 链条的高可靠性,源于公司对人力资源、技术研发和工艺装备持续不断的投入,并在众多的工业传动领域应用中得以证明。

When the customer are repairing or replacing the chains, it not only means extra purchase and labor cost but the lost from production shutdown and other unknown risks. Therefore, high reliability is the most important factor for you to select chain supplier. Your best choice will improve the equipment efficiency and reduce the maintenance cost.

❖ Chain reliability is mainly subject to its wearability and fatigue strength. ❖ Chain is designed and manufactured based on the factors described in the following diagram and on its actual working conditions, it under the assurance of authorized quality guarantee of ISO9001 Quality Management System and in achieving your expected goals with high reliability chains.

The high reliability of ❖ Chain is deriving from the company's continuous investments to human resource, technical R&D and equipment; it also has been proven in the applications of numerous industrial transmission fields.

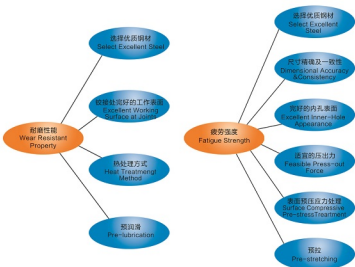

传动用滚子链

Transmission Roller Chain

◆ 单节距传动用滚子链以其高强度和持久耐疲劳著称，尺寸完全遵循ASME和BS标准，可组装成单排、双排和多排，以适用所传动的功率和不同的配置空间。

◆ 双节距精密滚子链是由短节距精密滚子链派生出来的，它的节距是后者的一倍，其它结构形式与零件尺寸相同。与短节距精密滚子链相比，它是一种轻型链条，适用于传递功率小，速度较低，传动中心距离更长的场合。

根据不同的工作环境，可供选择经镀锌、镀镍、镀铬、达克罗等不同表面涂层处理的链条。所有的表面处理方式均不含六价铬。

实验数据表明，链条磨损与润滑油的选择相关，

◆ 滚子链出厂初期，提供表面防锈的油膜，能够起到长效润滑减摩的效果，而且它的品质符合欧盟REACH规范，更环保。



◆ Transmission Roller Chain is famous for its high strength and continuous fatigue resistance; the chain dimensions can totally meet the ASME and BS standard, it can be assembled into single, double and multiple strands to apply for different driven power and allowed configuration space.

◆ Double Pitch Precise Roller Chain is deriving from short pitch precise roller chain with about two times of pitch length, but has same structure formation and size of components. Compare with the short pitch precise roller chain, it is a kind of light-duty chain, it suit for the application with smaller transmission power, lower operating speed and longer conveyor center distance.

Based on varied working conditions, there are different alternative coating treatments, such as zinc plating, nickel plating, chrome plating and dacromet plating etc. all the surface treatment material not contain the Cr6.

Experiment shows that the chain abrasion is related to the selection of lubricating oil, in the initial using stage of ◆ roller chain, the oil film which provides the surface rust prevention also has the effect of long term lubrication to ease friction. The quality of oil we select is correspond with the European REACH Standard, it is more environment friendly.

输送用滚子链

Conveyor Roller Chain

◆ 输送用滚子链是以单、双节距传动用滚子链为基础，并根据用途安装如A、SA、K、SK、D型等各种附件形成的，是物料输送领域中应用最广泛的链条产品。带各种附件的◆ 输送用滚子链规格齐备，适合不同工业领域的多样化需求。



◆ Conveyor Roller Chain is design based on the structure of single and double pitch transmission roller chain and completed by installing varieties of attachments on it, such as A, SA, K, SK and D type etc. It is the most widely used chain product in the application for material handling field. With a complete set of◆ conveyor roller chain with varieties of attachments, they are suitable for diversified demand in different industry fields.

农用滚子链

Agricultural Roller Chain

◆ 农用滚子链有S型、C型及由此派生的其它规格系列，并配套齐备的K、M、C、F等附件，广泛应用于农业、建筑、装卸输送等机械领域，其质量符合或超过原始设备制造厂的要求。同时合金覆层表面处理工艺技术已应用于链条的销轴零件，安装经表面合金覆层处理销轴的链条能够经受最严酷的环境考验。



◆ Agricultural Roller Chain includes S type; C type and other types of series derived from S type and C type, and are supplied with complete attachments such as K, M, C and F etc. It is widely used for such engineering fields as agriculture, architecture, conveying and loading equipment; the chain quality meets or exceeds the requirements from OEM. Furthermore, the new technique with alloy coating surface treatment has been able to be applied to chain pin, and the chain to be installed with surface treated pin by alloy coating may work under most severe conditions.





不锈钢滚子链 Stainless Steel Roller Chain

公司拥有超过40年的不锈钢链条制造经验。

根据不同的使用环境，不锈钢滚子链分别采用 SUS300系不锈钢材料制作，生产过程的每一环节都受到工厂ISO9001质量保证体系的严密监控，所形成的高品质及范围广泛的系列产品，适用于耐腐蚀性要求高的环境和高、低温工作环境。当有润滑要求时，可提供经美国农业部批准的润滑剂进行预润滑，这种润滑剂能够达到食品级的卫生标准要求。

不锈钢滚子链的套筒和滚子均使用冷挤压成型，链板多道冷轧硬化，这些工艺保证了  不锈钢滚子链的抗拉强度指标，比其它品牌的同类产品高出25%以上。

不锈钢滚子链除应用于食品、医药及耐酸耐碱等特殊工况外，在此基础上派生设计的多种不锈钢链条，如窗机链等大量应用于民用产品中。

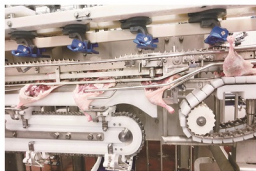

Company has more than 40 years of manufacturing experience of stainless steel roller chain.

Considering of different working environment, the Stainless steel chains are made from SUS300 series stainless steel, every manufacture process is strictly audit according to ISO9001 quality assurance system. These series of high quality and widely used products are suit for the extreme working condition. The company can also provide the lubricant which approved by USDA on the chain to pre-lubricate the chain, this kind of lubricant can meet the food grade health standard.

All the bush and roller for our stainless steel chain is form through cold extrusion, and the side plates harden through multiple times of cold rolling. With all these techniques ensured the tensile strength index of  Stainless Steel Roller Chain has climbed to more than 25% than similar production in other brand.

Except applies in food, medicine, acid/alkali resistance and other special working conditions, other types of stainless steel chain which derives from this base like windows machine chains are widely used for civil use.

重载弯板滚子链

Heavy-Duty Bent Plate Roller Chain

重载弯板链所有零件均采用优质合金钢材，并应用最先进的制造和热处理技术，获得更高的抗冲击强度。因链条本身具备其特殊的弯链板结构，使之更适于带有较大冲击性的载荷传动和起动频繁的间歇性工作环 境，主要应用于采矿、冶金、工程机械等行业的较大型设备及繁重工况下的动力传动。



All the components of Heavy-Duty Bent Plate Roller Chain are made from superior alloy steel; meanwhile, with the application of advanced manufacture and heat treatment techniques, the product obtains higher impact strength. The special bent plate configuration of this chain making it is more suitable for loading transmission with bigger impact and frequency starting. The chain is mainly used for power transmission of larger equipment and heavy working condition in such industries as mine, metallurgy, engineering machinery etc.





板式链 Leaf Chain

◆ 板式链选择优质合金钢制造，链板采用同步承载原理设计，生产过程精密控制内孔和孔心距尺寸，达到高精度和重复一致性，特殊的硬化工艺有效增强链条铰接处的耐磨性和整链疲劳强度。端接头采用合金钢锻造，联结螺纹挤压成形，以达到更高的安全可靠性，能经受原始设备制造商最严格的门架可靠性试验。

对更高安全系数的品质追求，已使 ◆ Leaf Chain 成为叉车行业和冷拔机行业原始设备制造厂的首选品牌，并大量应用于港口码头的吊装设备和厂矿、仓库、车站、机场、货场、流通中心和配送中心等场所。



◆ Leaf Chain, using the high quality alloy steel, the design of side plates adopt the synchronous load bearing principle, precision control the size of inner bore and pitch hole center distance during manufacture process to achieve high accuracy and repetition of consistency, also the special hardening technique can effectively enhance the wear resistance in chain articulation and the whole chain fatigue strength. The end joint is forge from alloy steel, connecting thread extrusion forming to achieve higher safety and reliability; it can withstand the strictest gantry reliability test from the original equipment manufacturer.

The quality pursuit of higher safety factor has made the ◆ Leaf Chain become the preferred brand of the OEM in forklift and cold drawing machine industry. And widely used in dock hoisting equipment, factories & mines, warehouses, stations, airports, freight yards, circulation centers, distribution centers and other workplaces.

板式链

Leaf Chain

AL系列板式链

AL系列板式链的零件源于ANSI滚子链标准，链板的外形尺寸和销轴直径等同于同节距滚子链的外链板和销轴，是一种轻系列板式链，适于直线往返传动结构。

BL系列板式链

BL系列板式链的零件源于ANSI滚子链标准，链板的外形尺寸等同于滚子链的内链板，但链板的厚度加厚，销轴的直径加大，因此是一种重系列板式链，适于直线往返传动结构。

LL系列板式链

LL系列板式链的零件源于BS滚子链标准，链板的外形尺寸和销轴直径等同于同节距滚子链的外链板和销轴，是一种轻系列板式链，适于直线往返传动结构。

AL Series Leaf Chain

The parts of AL Series Leaf Chain are derive from the ANSI roller chain standard, the side plate overall size and pin diameter are equivalent to the parts of roller chain in same pitch level, it is a kind of light series leaf chain, which suitable for straight back and forth transmission structure.

BL Series Leaf Chain

The parts of BL Series Leaf Chain are derive from the ANSI roller chain standard, the side plate overall size is equivalent to the inner plate of roller chain in same pitch level but with ticker plate thickness and larger pin diameter, so it is a kind of heavy series leaf chain, which suitable for straight back and forth transmission structure.

LL Series Leaf Chain

The parts of LL Series Leaf Chain are derive from the BS roller chain standard, the side plate overall size and pin diameter are equivalent to the parts of roller chain in same pitch level, it is a kind of light series leaf chain, which suitable for straight back and forth transmission structure.



钢制销合链

Steel Pintle Chain

 钢制销合链以其简洁的结构，与AS2、ASS、BRH、F12H、G30、M1等多种附件的灵活组合，广泛应用于食盐、肥料等颗粒状物料的撒布机，畜牧业中的饲料分选机和牧草抛洒处理设备，木材加工中的低速输送设备及其它类似的传送系统。公司凭借高效的专用制造设备、严格的过程质量控制和计算机网络订购服务系统，能够迅速为全球范围内的客户提供优质的链条产品。



With Simple configuration and flexible combination of chain and different attachments like AS2, ASS, BRH, F12H, G30 and M1,  Steel Pintle Chain is used for spreader for granular material such as salt and fertile etc, feeder /Sorter in stockbreeding and forage spraying process equipment, low-speed conveyer equipment in wood processing and other similar delivery systems. With high-effective special manufacturing machinery, strict in-process quality control and computerized order system network, the company can supply excellent chain product in a timely manner for clients all over the world.

焊接弯板链

Welded Mill & Drag Chain

 焊接弯板链是针对带强烈冲击、物料磨损及含有大量粉尘的木材加工环境设计的，能够经受高负荷冲击和持久抗磨损，从而延长使用寿命。

弯板链节采用新型专用自动焊机焊接，一次装夹同时完成双侧焊缝，链节上的各类附件采用机器人焊接，确保稳定的焊接质量和尺寸精度。同时焊接过程严格按工艺评定要求进行焊缝强度、焊接熔透性、热影响区硬度等项目的检查。

规格齐全的WH、WR两种窄系列和WDH、WDR两种宽系列的焊接弯板链与各种附件的灵活组合，能够满足粮油、制浆造纸、木材加工等各类生产线上多样性需求。



In consideration of lumber processing conditions with strong impact, material wearing and a lot of dusts,  Welded Mill & Drag Chain is designed for being capable of standing for high load impact and durable wear to prolong the usage life.

Cranked link weld by a new type of special automatic welding machine, it can complete the weld seam at both sides simultaneously, to use robot weld each kinds of attachment onto the chain to ensure the weld quality and dimensional accuracy. In the mean time, the welding process is strictly according to the process assessment requirements for the inspection on weld seam strength, welding penetration, hardness in heat effect area and other items.

The flexible combination of a complete set of WH & WR narrow series of chains & WDH and WDR wide series of welded bent plate chains with varieties of attachments can meet diversified demands of varies type of production lines in grain & oil, pulp & paper, lumber processing and other industries.



糖机链

Sugar Chain

我们对采用甘蔗和甜菜制糖的工序和设备工况有全面的了解，同时拥有丰富的设计经验和制造技术，能够为全球范围内的制糖工业，全面提供加工系统和发散系统中传动、提升和输送用途的专用糖机链条。

基于制糖生产线的特殊工况，糖机链采用独特的结构设计，以确保在恶劣运行条件下仍维持良好的链条铰接处及滚子的灵活转动功能。为提高链条使用寿命，糖机链的销轴和套筒零件大量采用了马氏体不锈钢材料，这些材料在真空炉内进行热处理，不仅可获得类似合金钢的硬度和冲击韧性，同时赋予其表面良好的抗腐蚀性能。



We have a comprehensive understanding about the process and equipment used in refining sugar by using sugar cane and sugar beet, and has rich design experience and manufacturing technique, we are able to supply special sugar chains for the applications of transmission, elevator and conveyor in the systems of processing and transpiration for worldwide sugar industries.

Based on the special working conditions of sugar production line, sugar chain use the unique design of structure to ensure the favorable flexibility of roller and chain hinged place under harsh running condition. In order to increase the service life, our sugar chain adopt martensite stainless steel as the material for bush and pin, after heat treatment in vacuum furnace, it not only obtain the hardness and impact toughness which similar to the alloy steel, but also gives the good corrosion resistance on its surface.



棕榈油链 Palm Oil Chain

 棕榈油链是基于我们对棕榈油压榨生产线应用研究的成果。制造过程通过合理选材、精密加工、特殊热处理、精确装配和预润滑等工序的严格控制，所达到的尺寸一致的精确性使链条与链轮间的啮合更具完美，持久耐磨损的特性使品质更为卓越。



 Palm Oil Chain is the product based on the achievement of our application research to palm oil squeeze production line. Through the strict control of working procedures such as reasonably selecting suitable material, precision finishing, special heat treatment, precision assembly and pre-lubrication etc. we gain the consistent accuracy of dimensions, it makes the perfect gearing between chain and sprocket, and the long wear resistance characteristics to make the quality more outstanding.





挖沟机链

Trencher Chain

土石方机械施工行业所面临的工作环境复杂多变，既有砂土、粘土，也有冻土、风化石或砂石，包括挖掘深度和宽度的调整，使建筑工程机械在工作过程中承受载荷和碰撞力随时都在发生变化。

挖沟机链是为适应各种特性的地下施工环境而设计制造的，套筒与滚子表面渗碳硬化处理，销轴感应硬化处理，从而具备表面坚硬与心部强韧性的良好匹配。卓越的机械性能和精确的尺寸一致性，确保每批次的链条都拥有高的冲击韧性和疲劳强度，满足带有较大冲击的载荷传动和起停频繁的间歇性工作环

境。公司所生产的挖沟机链条，由于高可靠性带来长寿命的使用特性，已成为公司为顾客创造价值的经典诠释。



The earthwork machinery construction industry faced with complex and changeable working environment; there is sand, clay, frozen soil, wind fossils or gravel, including the adjustment of excavation depth and width, so that in the operating process the load and impact force of construction machinery changes at any time.

Trencher Chain is design and manufacture to adapt to various types of the underground construction environment, with case carburized bush & roller and induction hardened pin, the chain own the perfect match of surface stiffness and core toughness. The excellent mechanical properties and accurate dimensional consistency can ensure that every lot of the chain has the high impact toughness and fatigue strength to satisfy the intermittent work environment with large impact load transmission and frequent activation. The company's Trencher Chain has already become the classic interpretation to create value for customer because of the long life which derives from high reliability.



啤酒行业用链 Beer Canning Production Line Chain

在啤酒饮料行业的动力传动与输送技术领域，公司已有40年的技术和经验沉淀积累。并凭借对卓越的不懈追求，黄山牌的啤酒饮料行业用链已发展成为中国大陆的第一品牌。

我们能够跟上行业现代技术的发展，是由于我们的链条设计工程师，与国内啤酒饮料设备制造厂建立了持续的技术合作，能够时刻把握啤酒饮料行业生产设备的最新设计潮流，并凭借自己的学识和经验，进行创新化设计和改进。

公司是啤酒饮料设备制造领域中最优秀的链条供应商，所生产形成完整系列的啤酒灌装生产线链条，能够满足不同品牌的洗瓶机、灌装机、贴标机、无压力输瓶等啤酒生产线高速、平稳输送的运行需求。



Company has more than 40 year's accumulation of technology and experience in the beer and beverage industry and its power transmission technology field. By relentless pursuit of excellence quality, Huangshan beer & beverage industry chain has developed into the top brand in Chinese mainland.

We set up a continuous technical cooperation between our chain design engineers and domestic beer & beverage equipment manufacturers so that we could always grasp the latest design trends in this industry, and use our knowledge and experience for innovative design and improvement to keep pace with the development of the modern technology in this industry.

The company is the most outstanding chain supplier in Beer & Beverage Equipment Manufacturing field, the production of complete series of chain for beer filling production line can meet the fast and steady operation needs for the bottle washing machine, filling machine, labeling machines, pressure-free bottle conveyor and other beer production lines from different brands.



啤酒行业用链

Beer Canning Production Line Chain

a. 不锈钢平顶链

公司是国家标准GB/T 4140《输送用平顶链和链轮》国家标准的起草单位，其工艺技术和品质在国内处于领先，并获得多项产品和制造技术专利。

根据啤酒饮料生产线的不同区段，可分别提供由300、400系及高强度且抗磨损性能优越的特殊铬镍钢等不锈钢材料制造、宽度在76.2~190.5mm范围、单铰或双铰、直线或侧弯等多规格的输送用平顶链。

公司拥有的六台国内唯一的平顶链八工位自动成形装配机，并配置链板自动冲压生产线、链条预拉伸台、表面研磨抛光机、导向板自动焊接生产线等当今国内最先进的平顶链制造装备，不仅生产高效，而且链条品质稳定。

b. 工程塑料平顶链

黄山牌的工程塑料平顶链，采用高强度改性工程塑料注塑成形，拥有更好的耐酸耐碱性能，运行平稳，低噪声。

这种链条主要运用于啤酒饮料行业易拉罐包装的饮料生产线，同时在电子产品、烟草包装生产线上也有广泛的应用。

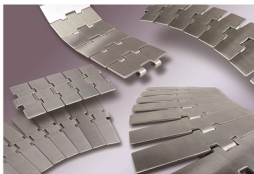

Stainless Steel Flat Top Chain

Company is the National Standard drafting unit to create the GB/T 4140 "Conveying Flat Top Chain and Sprocket", the quality and technology is at the top of domestic market, and obtains many patent of product and manufacturing technology.

According to different sections of beer & beverage production line, we could provide the different types of flat top chains which manufactured from 300, 400 series and special high-strength & superior abrasion resistance chrome stainless steel materials, either in single hinge or double hinge, straight conveying or side flex conveying, and the chain width is in the range of 76.2~190.5mm.

Company owns the only six sets of flat top chain eight-position automatic forming assembly machine is Chinese mainland, combined with the most advanced flat top chain manufacture equipment such as plate automatic stamping production line, chain pre-stretch & length measurement machine, surface polishing machine, guide plate automatic welding production line, it not only increased the production efficiency, but also ensured the quality stability.

Engineering Plastics Flat Top Chain

Huangshan Engineering Plastics Flat Top Chain, injection molding from high-strength modified engineering plastics has better acid and alkali resistance, can operate smoothly with low noise.

This chain is mainly used in zip-top can packaging production line for the beer & beverage industry, it also widely apply to the production line of electronic products & tobacco packaging.

啤酒行业用链

Beer Canning Production Line Chain

c. 洗瓶机链

洗瓶机链是啤酒生产线上的核心传动件，在碱液中运行，高的耐磨性能仅仅是链条必须赋予的基本特性之一，更高的要求是链条的制造精度，包括附板的高度和链条的长度精度，才能保证啤酒瓶的清洗净程度。

公司生产的洗瓶机链依据高于国际标准的企业技术标准设计制造，以其近乎完美的品质行销推广，几乎囊括了国内青岛、华润、燕京三大啤酒集团下属的啤酒生产厂的维修市场，并且是国内主要啤酒设备制造厂的主流供应商，在行业内处于领跑者的位置，这也是以高品质著称的  链条，在啤酒饮料工业传动领域中又一次得到证明。



Bottle Washer Chain

The Bottle Washer Chain is the core transmission part in beer production line, operating in lye, the high wear resistance is only the basic characteristics of the chain; it also need the high chain manufacturing precision including the height of the attached plate and the chain length accuracy to ensure the cleanliness of beer bottles.

Our bottle washer chain design and manufacture based on the enterprise technical standards which is higher than international standards, marketing based on its practically perfect quality level, we almost dominate the domestic maintenance market under the top three beer group – Qingdao, China Resources, Yanjing, and we are the main supplier for domestic beer equipment manufacturers, became the leader of this industry. It is the another proof for  chain which known for its high quality in the field of beer and beverage transmission industry.



冷食行业用链

Cold Drink & Food Process Chain

根据不同的生产线需求，❖冷饮食品链条分别采用SUS300/400不锈钢材料制作，所形成的系列链条能够完整配套挤压冰淇淋生产线、花色雪糕生产线、多功能冰淇淋灌装、包装机等设备。最新的速冻隧道链在销轴与套筒之间安装了带有特殊涂层的衬套，是一种无需润滑免维护的创新设计产品。



According to different requests of production lines, ❖ Cold Drink Food Process Chain is manufactured from SUS300 or SUS400 stainless steel material, the chains can equipped fully with the equipment such as extrusion ice-cream production line, color ice-cream production line, multifunctional ice-cream filling machine and packaging machine. The newest quick-freezing tunnel chain is installed with a special coating sleeve between pin and bushing which is an innovative product with the feature of lubrication-free and maintenance-free.



筑路行业用链 Paver Chain

公司积四十年的专业制造链条技术和经验，所开发的应用于沥青搅拌、摊铺等筑路行业的链条产品，完全符合原始设备制商的最高技术标准，最大程度满足沥青搅拌站、摊铺机、地面修整等工程设备上的传动和输送功能。链条在生产过程中的每一环节都受到工厂质量保证体系的严密监控，确保每批次的链条都拥有高的抗拉强度和疲劳强度。

◆ 筑路行业链条产品规格齐备，能够完整配套整机或生产线上的水平及提升输送设备，为筑路行业工程设备制造和应用厂家提供全面的链条产品配套服务，满足筑路机械的多样性需求和客户的高质量标准。

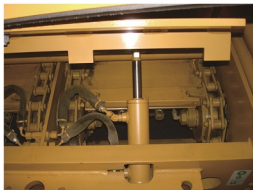

Company accumulated 40 years of professional manufacturing technology and experience, developed the chain products used in asphalt mixing, paving and other equipment in road-building industry, the chain is fully comply with the highest technical standards of original equipment manufacturer, it can meet the transmission function requirement of the engineering equipment like asphalt mixing station, pavers, ground repair etc. to the greatest extent. Each link in the production process is closely monitored by the Factory quality assurance system to ensure that every batch of chain has the high tensile strength and fatigue strength.

There are complete range of ◆ Road-building industry chain, which can support the integrity of machine or the horizontal and elevator conveying equipment in production line. It provide the comprehensive product supporting service for the road construction industry engineering equipment manufacturers to meet the diverse needs of road machinery and high quality standards from customer.





水泥行业用链 Cement Chain

历经多年的经验积累和持续改进，专为水泥行业恶劣工况应用而设计的取料机链、提升机链、鳞板输送机链、拉链机链等，选材精良，生产过程的每一环节都受到工厂ISO9001质量保证体系的严密监控，所形成的NSE系列提升机链、ER系列套筒结构提升机链、SPN取料机链和STN鳞板机链等高品质的系列产品一直在为海螺、SCG等水泥制造商提供服务，并获得称赞。

SPN取料机链系列应用范围：石灰石取料机，粘土取料机，铁矿石取料机，砂岩取料机，原煤取料机等。

NE、NSE、ER系列斗式提升机链应用范围：出、入库提升机，出、入磨提升机，出、入辊提升机，石膏提升机，水泥成品提升机等。

STN鳞板机链系列应用范围：熟料输送机等。



After years of experience accumulation and continuous improvement, the feeder chain, bucket elevator chain, apron conveyor chain, flow chain conveyor chain, etc. which specially designed for operating in the harsh conditions, excellent material, every aspect of the production process is closely monitored by the factory ISO9001 Quality Assurance System, the resulting NSE series elevator chain, ER series bush elevator chain, SPN feeder chain, STN apron conveyor chain and other high-quality products are keep providing service for Conch, SCG and other cement manufacturer and win praise.

The application range for SPN reclaimer Chain series: Limestone reclaimer, clay reclaimer, iron ore reclaimer, sandstone reclaimer, raw coal reclaimer etc.

The application range for NE, NSE, ER series bucket elevator chain: elevator for in-out stock process, elevator for in-out mill process, elevator for in-out roller process, gypsum elevator, cement products elevator, etc.

The application range for STN series apron conveyor chain: Clinker conveyor, etc.



粮油行业用链 Grain & Oil Industry Chain

公司生产的粮油行业用链条三种结构，其中滚子（或套筒）链和焊接弯板链结构的链条通过与各种附件进行灵活的组合，满足粮油加工生产线上的多样性需求。块式结构方式的链条主要应用于浸出器设备内部的物料输送。

粮油行业用链，采用有限元分析技术和特种合金钢制造，生产过程使用高效的加工工艺和设备，为顾客提供低成本链条的同时保证产品的高质量。浸出器的块式链链板采用CNC加工，具有精确的尺寸精度，同时链板内孔镶有抗磨损和耐腐蚀的轴套，以提高链条的可靠性和使用寿命。



Company produced three kinds of chain structure in grain and oil industry, through a flexible combination of various attachments, the roller (or bush) chain and welded steel chain can meet the diverse needs of grain and oil processing production lines. The chain of block structure is mainly used for material handling inside of the extractor equipment.

Grain & Oil Industry Chain are manufactured based on finite element analysis technology and special alloy steel, using efficient processing technology and equipment during production process, provide the chain to customer with low-cost while chain ensuring high product quality.

Use CNC to machine the block chain side plate to get the precise dimension precision, while the inner hole of chain plate is inlaid with wear-resisting and corrosion-resistant bush to improve the reliability and service life of the chain.





冶金行业用链 Metal Iudrgal Industry Chain

公司长期为矿山冶金行业提供产品和设计服务，在矿山冶金行业用链上拥有丰富的设计和制造经验，因此矿山冶金行业用链是公司工程链中最具特色的系列产品。精确的尺寸一致性，稳定的机械性能，确保每批次的链条都拥有高的抗拉强度和疲劳强度，为国内各大钢厂和有色金属冶炼厂所采用，应用于铸造机，残极加料机，热轧线材生产线，钢坯、钢锭连续铸造生产线，钢坯加工输送线，刮板除尘箱式输送机。

一种新的大节距、滚轮内镶轴承并具有高度防尘能力的链条已应用于钢厂的堆取料机设备，这种结构的链条即使在多尘环境中，也具有同等的性能和传送效率。

Company has a wealth of design and manufacture experience for produce chain which used in mining and metallurgy industry, provide products and design services for the mining industry over a long period, as a result, this chain is the most distinctive series of products in engineering chains of the company. With accurate dimensional consistency and stable mechanical properties, it can ensure that each batch of the chain has high tensile strength and fatigue strength, the chain have been used in major steel mills and nonferrous metal smelters in the domestic, it is applied to the casting slag machine, anode scrap feeder, hot-rolled wire production line, steel billet & ingot continuous casting production line, billet processing conveyor line, scraper de-dusting conveyor, etc.

A new type of chain with large pitch, strong dust-proof bearing roller has been applied to the stacker reclaimer equipment in steel mills, which has the equal performance and transmission efficiency even in the dusty environment.



烟草行业用链 Tobacco Industry Chain

烟草行业用链在国内烟草市场上取得了巨大成功，它的成功，主要是源于我们与国内烟机研究所的紧密合作，与国内各大烟厂的良好关系，正是烟机设备的设计者和链条的使用者的建议，使我们更深入地了解制烟工艺流程和设备工况，并给品质的持续改进提供方向。

公司开发的烟机专用链包括复烤、储柜、喂料等系列，在红云红河、红塔、上海等烟草集团生产基地的自动生产线得到了广泛应用。同时，滚子链在烟草行业的物流和仓储系统也被大量采用。

应用于烟草行业的免维护喂料机链是公司开发的专利产品，主要应用于卷烟制丝生产线上的仓储式喂料机，具备低噪音、免润滑和高精度等特点。



主要应用范围

烟叶复烤生产线
真空回潮机
定量喂料机
膨化贮柜线
包装自动生产线等

The Tobacco Industry Chain has achieved great success in the domestic tobacco market, it mainly stems from the close cooperation with domestic tobacco machine research institute and the good relationship with domestic cigarette factory, owing to the feedback from the equipment designers and users we were able to get an in-depth look of tobacco production process and equipment working conditions, which provide the direction for our continuous quality improvement.

The company developed the special chain for tobacco machine, including the series of re-drying, storage cabinet, feeding and so on; they are widely used in the automatic production line from production base like Hongyun Tobacco, Hongta group, Shanghai Tobacco etc. At the same time, roller chain are also adopt in the logistics and warehousing systems of tobacco industry.

The maintenance-free feeder chain which used in tobacco industry is company's patented product, with the features of low-noise, lubrication-free and high-precision it is mainly used in the storage feeder in tobacco shred production line.

Main application Range:

Flue-cured Tobacco Production Line
Vacuum Moisture Regain machine
Constant Feeder
Bulk Storage Cabinet
Automatic Packing Production Line



水处理行业用链

Water Treatment Industry Chain

公司已为各种水处理设备提供了大量的水处理链条，以应用于中转折水处理、砂粒沉积箱、初次沉积和二次沉积等水处理设备生产线。为适用不同水处理设备的功能要求，公司不仅提供包括不锈钢、特种合金钢材材料制作的水处理链条，还包括提供铸造成型的水处理链条。

节距长达24吋水处理链条，是基于水处理工艺流程不同工段的工况和使用要求进行开发的。链条零件通过选择不同材料进行多种组合，形成多种不同的产品特性，以适应更广泛的应用范围。



The company has supplied large number of chains to a variety of water treatment equipment for the water treatment equipment production lines including water treatment transfer, sand deposit box, initial deposition and secondary deposition. In order to meet function requirements of different water treatment equipment, the company not only provides water treatment chains made from stainless steel or special alloy steel materials, but also provides casting water treatment chain.

The 24-inch-long water treatment chain is developed based on the working conditions and requirements of different sections in water treatment process. Chain components are composed of different materials to form a variety of different product feature then adapt to suit a further wide field of applications.

木材加工行业用链 Timber Processing Industry Chain

木材加工行业用链大量应用于原木深加工和人造板生产线上。在原木初加工阶段主要选择各类米制输送链、焊接弯板链等，在深加工阶段主要采用高精度的尖齿滚子链和夹持输送链。

其中，尖齿滚子链，是精密滚子链的派生产品，同等采用AISI标准滚子链。链条与链轮啮合传动时，链板所带的尖角用于夹持木材输送，最高传送速度可达到380m/min，应用于木材加工生产线上的精确剖切设备。



The HS Timber Processing Industry Chain is largely used in wood deep processing and artificial panel production line. At the beginning of the processing stage, the main selection of products is metric conveyor chain and welded steel chain, but in the deep processing stage, it mainly uses the high-precision sharp-toothed roller chain and hold conveyor chain.

The HS Sharp Top Chain is a product derived from precise roller chain corresponds to AISI standard roller chain. When the chain and sprocket are engaged together during transmission process, the sharp points on the sidebar are used for lumber transmission with highest speed which can reach 380m/min. The chain is mainly used for precision section-cutting equipment on lumber processing production line.



汽车生产线用链

Automobile Production Line Chain

公司与机械工业第四设计研究院的合作，已有10年之久，依托机械四院的设计能力，我们在汽车生产线输送链条领域，具有领先的技术优势。十年来，我们先后为上海大众、北京现代、南京名爵、陕重汽、柳汽、海南马自达、江淮、吉利等提供了众多汽车生产线上的输送链条，其中尤以喷涂线链条最为出色，能够长期在300℃以下的工作温度下运行可靠，具有长的使用寿命。



The history of cooperation between our company and the SCIVIC ENGINEERING CORPORATION is more than 10 years, relying on the design capacity of SCIVIC, we owned the leading technical advantages among the conveyor chain field of automotive production line. Over the past ten years, we have been provide a large number of Automobile Production Line Chain to SVW, Beijing Hyundai, Nanjing MG, Shaanxi automobile, Liuzhou Auto , Hainan Mazda, JAC, Geely AUTO, etc. The spraying line chain in particular, it can long-time run in the work environment with operating temperature which up to 300℃, it take on a long service life.



煤炭行业用链 Coal Industry Chain

适合煤炭开采和加工行业的  链条主要包括重载弯板滚子链、套筒链、取料机链和洗煤机链，分别应用于滚筒式破碎机、装料破碎机、堆取料机和煤处理加工厂。这些链条采用更高的技术标准设计和制造，拥有更高的疲劳强度和更长的使用寿命，在严酷的工况下保持长时间连续工作的能力，为顾客降低维护成本和减少停机时间。



The  chain which suitable for coal mining and processing industry mainly includes heavy-duty crank plate roller chain, bush chain, reclaimer chain and coal washing machine chain, they are respectively used in roller crusher, loading crusher, stacker and coal processing plant. These chains are designed and manufactured based on stricter technical standards, with higher fatigue strength and longer service life; the chain owned the ability to maintain long-term continuous work under harsh conditions to reduce maintenance costs and downtime for customers.

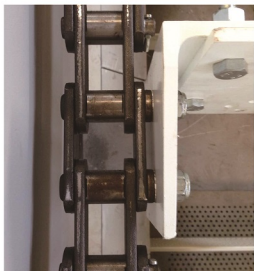



沼泽地作业设备用链 Swamp Equipment chain

公司针对沼泽地作业设备开发的行走驱动链条，是为适应沼泽、河滩、盐沼等各种特殊复杂地表地区的工作环境而设计制造的。设备上的行走履带板与链条内链节上的弯板相联结，可承受更大的重力。套筒与滚子表面渗碳硬化处理后，具备表面坚硬与心部强韧性的良好匹配。各零件间适宜的运动间隙及销轴端的热铆结构，确保链条在复杂的工况条件下运转自如，而且在出现严重腐蚀情况下，仍维持链条的基本使用功能。



The drive chain which our company developed for the swamp Operation Equipment is design and manufacture to adapt to work on the swamp, floodplain, salt marshes and other special complicated surface areas. The Walking Crawler board on the equipment is connected with the curved plate on the chain inner links, it can withstand greater gravity. After carburizing and hardening the bush and roller surface, due to the perfect match between surface stiffness and core toughness, the appropriate movement clearance between each components and the hot riveting structure of the pin end, it not only ensure the chain operates freely under the complex working conditions, but also maintains the basic function of the chain in case of severe corrosion on chain components.



塑料薄膜拉伸行业用链 Film Transverse Pulling Chain

在塑料薄膜双向拉伸链条制造领域，我们拥有超过10年的成功经验，近七十台套的  链条应用于国内BOPP、BOPET、BOPA等薄膜拉伸机生产线，在320m/min高速运行下稳定可靠，品质符合原始设备制造厂的要求。我们的技术团队正专注于更高速的薄膜横拉链的研发，通过持续的技术创新，为薄膜拉伸行业提供更高品质的链条产品和专业化服务。



We have collected over 10 years successful experience in the manufacturing field for plastic film bidirectional pulling chain, there are approx. 70 sets of  Chains were applied to the domestic plastic film pulling production line such as BOPP, BOPET and BOPA etc. with steady and reliable running under high-speed of 320m/min, the chain quality can meets the requirements from OEM. Our technical team is now focusing on the research and development for film transverse pulling chain operating under higher speed; meanwhile, through continuous technique innovation, we will supply high quality chain product and professional service to film pulling industry.





再生资源回收处理行业用链

Chain used in resources recycling industry

再生资源回收处理行业用链的开发是公司承担促进物资循环利用、降低地球环境负担社会责任的又一进步。十年来，公司生产的众多  链条运行于废钢处理生产线、报废汽车拆解生产线、生活垃圾综合利用环保处理生产线、垃圾焚烧发电厂、水处理厂等，体现了工厂的创造性在环境保护中的作用。



The development of chain used in resources recycling industry is the another progress of our company to undertake the social responsibility like promote material recycling and reduce environment burden. In the last decade, company provide numerous  Chains use in scrap steel processing line, scrap auto dis-assembly line, house hold waste ROHS processing line, waste-to-energy power plant and water treatment plant etc, it reflect company's creative role in environment protection.

制浆造纸行业用链

Chain used in pulp and paper industry

从木材堆场到最终产品，针对各个处理流程的特殊需求，公司可提供以灵活、高效、可靠的链条产品应用于传送系统中的各类设备，达到高处理量的同时保证传动及输送的可靠性及稳定性。



From timber storage yard to end products, Company can provide flexible, efficient and reliable chain products which applied to a wide variety of devices in transmission system for the special requirement in every process flow. During operating process, the products can make sure the devices achieve large thought concurrent with ensure the reliability and stability.

采油行业用链 Petroleum Industry Chain

公司可为采油行业可提供油田滚子链和抽油机链两种系列产品。为确保这些链条高的可靠性，零件的加工技术显得至关重要，相比于其它链条的生产制造，油田滚子链具有以下特性：

链板,更宽的腰部尺寸,提高链板疲劳强度更高等级的合金钢材料,严格控制化学成分,获得一致的热处理结果。

热处理后钢球挤孔, 预压应力的存在获得最佳的抗裂纹延展能力, 过盈配合的连接链板的孔口带成形锥角, 方便客户安装, 但不减弱其抗疲劳性能。

销轴、套筒、滚子, 优化的碳氮共渗微变形处理工艺, 销轴保持近乎完美的直线度, 挤压成型的套筒和滚子, 具有更高的圆度、同轴度和表面粗糙度。

炉内气氛准确检测和热控制的热处理设备, 来自于专业实验室的韧性检测方法, 适用于700型、900型、1100型等系列抽油机设备的抽油机链条, 不仅产品线较为完整, 可供顾客的多元化选择, 同时该系列链条具有能够承受更大载荷和高疲劳强度的特性。



The company can provide two series of chain – oil field roller chain and pumping unit chain for petroleum industry. In order to ensure the reliability of these chains, the machining technology of becomes great importance, compared to the manufacture of other chains, oil field roller chain has the following characteristics:

Side plate, Wider waist size, Higher grade alloy steel materials which could improve fatigue strength of plate, strict control of chemical composition to reach reach the consistency of heat treatment.

Use steel ball squeeze the pitch hole after heat treatment, the compressed stress after squeeze will let the pitch hole gain the optimum ability to resist crack extension, Forming cone angle on pitch hole of interference fit connecting plate can help customer to install it on the equipment but do not weaken its fatigue resistance

Pin, Bush and Roller, Through the optimized carbonitriding micro deformation treatment process, the pin maintain a near-perfect straightness, Extruded bush and rollers in higher roundness, coaxiality and surface roughness

Heat treatment equipment with accurate detection and control on furnace atmosphere

The professional laboratory toughness testing method, For the pumping unit chain which suit for 700, 900, 1100 series pumping units, with the complete product line which available for the diversification of customer's choice, this series of chain also has the ability to withstand greater load and high fatigue strength.



◆ 链条良好的品质声誉不仅来自于第三方实验室提供的良好性能试验数据，更是源于来自各行各业的链条使用者对 ◆ 的高度评价。

The good reputation of ◆ chain not only comes from the good performance test data, but also from the satisfaction feedback of ◆ chain user in different industries.

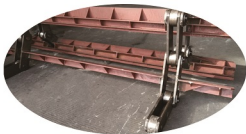

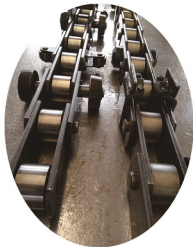

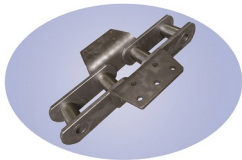
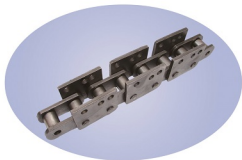

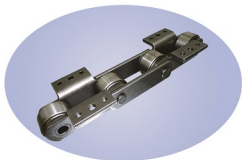

基于工厂的研发实力及长期积累的各种专有技术，我们能够为客户提供动力传动和物料输送领域高度定制化的链传动产品和服务，并由此建立相互信任和长期合作的关系。

Based on the R&D strength and long-term accumulated proprietary technologies of the factory, we are able to provide the highly customized chain transmission products and services to customers in power transmission and material handling area then establish the mutual trust partnership and long-standing cooperation.

NOTE



HS CHAIN

A series of horizontal dashed lines for writing notes.



更多的资讯请联系

For more information, please contact:

安徽黄山恒久链传动有限公司

Anhui Huangshan Hengjiu Chain Transmission Co., Ltd

中国·安徽省绩溪县生态工业园区清凉峰路18号

No.18 Qingliangfeng Road, Ecology Industry Zone, Jixi, Anhui, China

Tel: +86 563 8150161 8150162(国际销售部 Export Dept.)

+86 563 8150171 8150172(国内销售部 Domestic Sale Dept.)

Fax: +86 563 8163690

Post Code: 245300

<http://www.hschain.com.cn>

E-mail: export@hschain.com.cn(国际销售部Export Dept.)

sale@hschain.com.cn(国内销售部Domestic Sale Dept.)